

CORREDERA DE DOS HOJAS

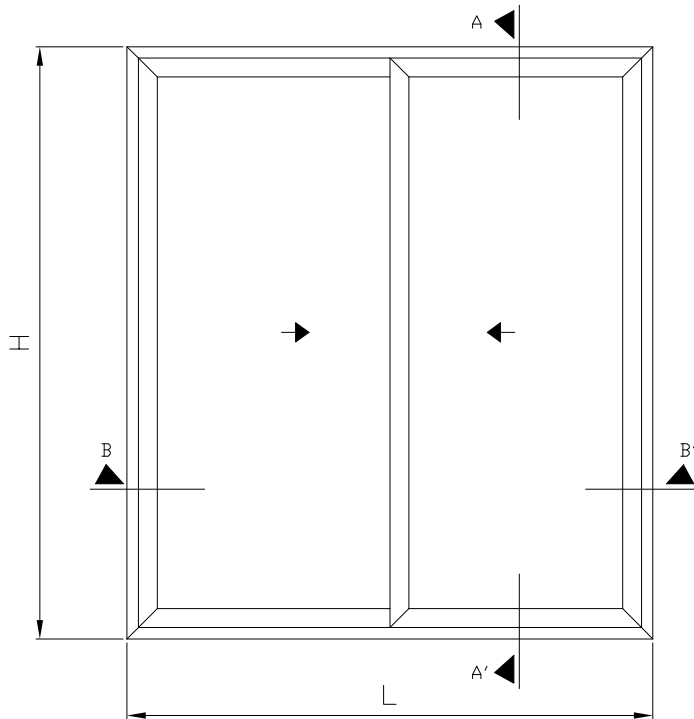

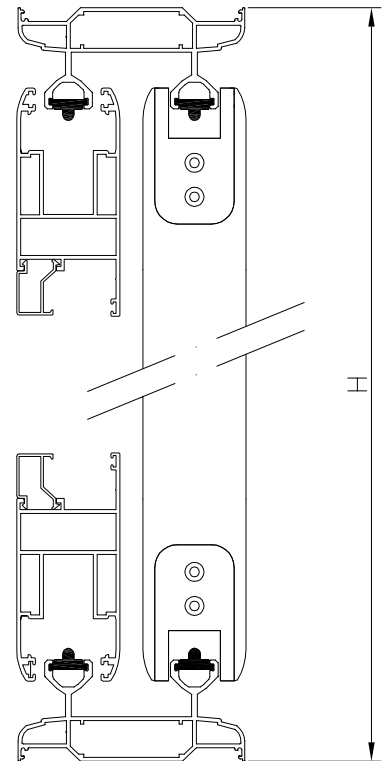

SECCION A-A'



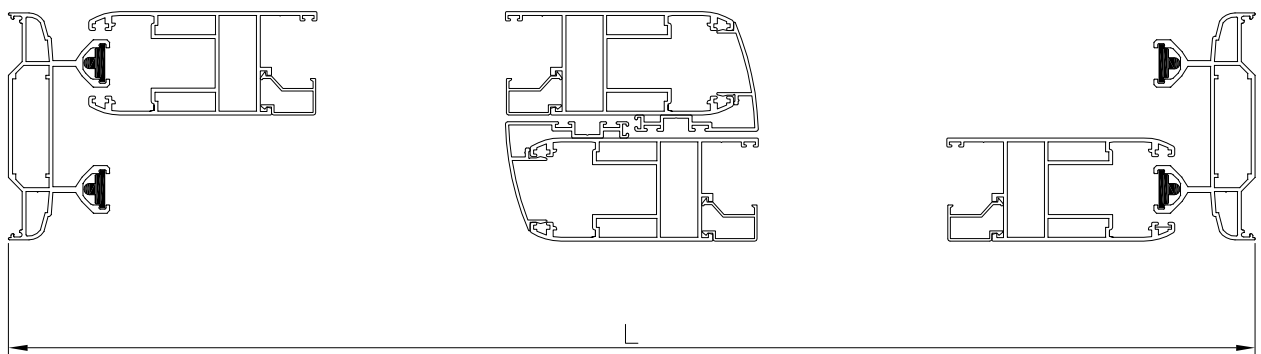



SECCION B-B'



Medidas de corte (mm)

-  Marco superior: L
-  Marco lateral: H
-  Marco inferior: L

-  Hoja lateral-central: H-73
-  Hoja ruedas: (L/2)+8
-  Clip central: H-73
-  Perfil guia lateral: H-83.6
-  Perfil guia superior-inferior: L-92

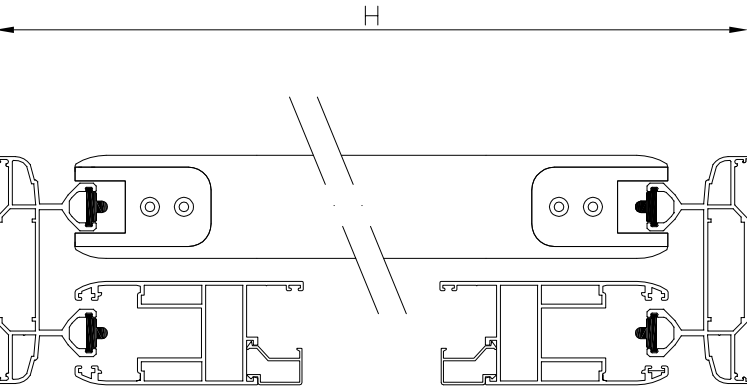





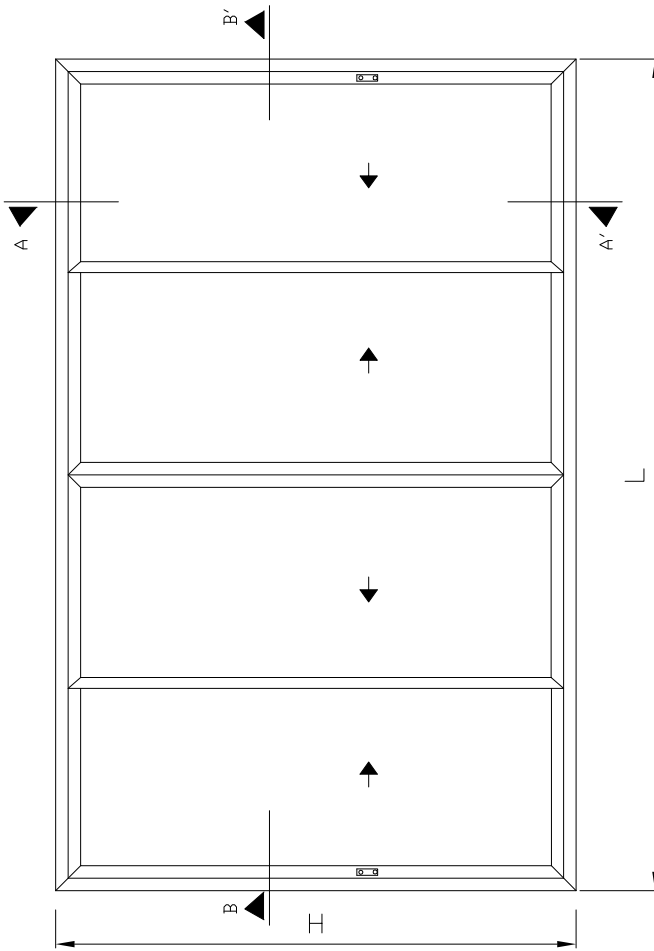



SECCION A-A'

CORREDERA CUATRO HOJAS



Medidas de corte (mm)

-  Marco superior: L
-  Marco lateral: H
-  Marco inferior: L
-  Hoja lateral-central: H-73
-  Hoja ruedas: (L/2)+8
-  Clip central: H-73
-  Perfil guia lateral: H-83.6
-  Perfil guia superior-inferior: L-92

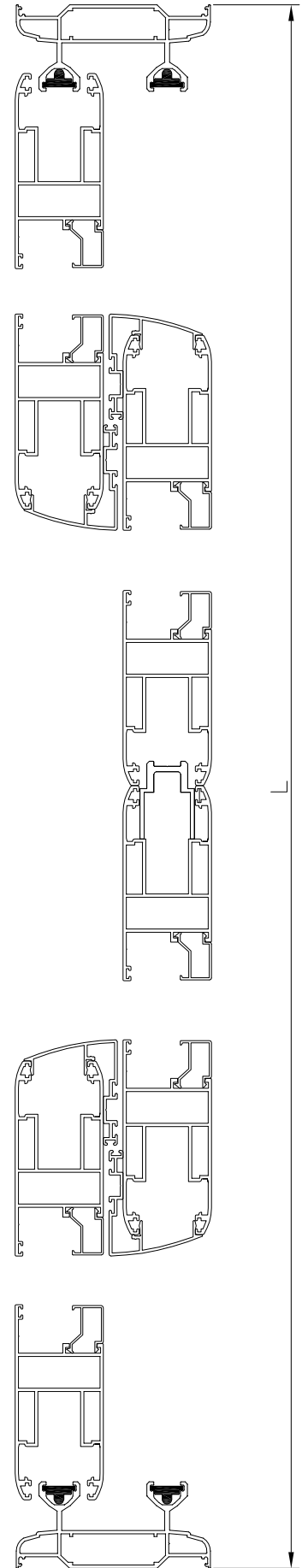

CORREDERA DE DOS HOJAS

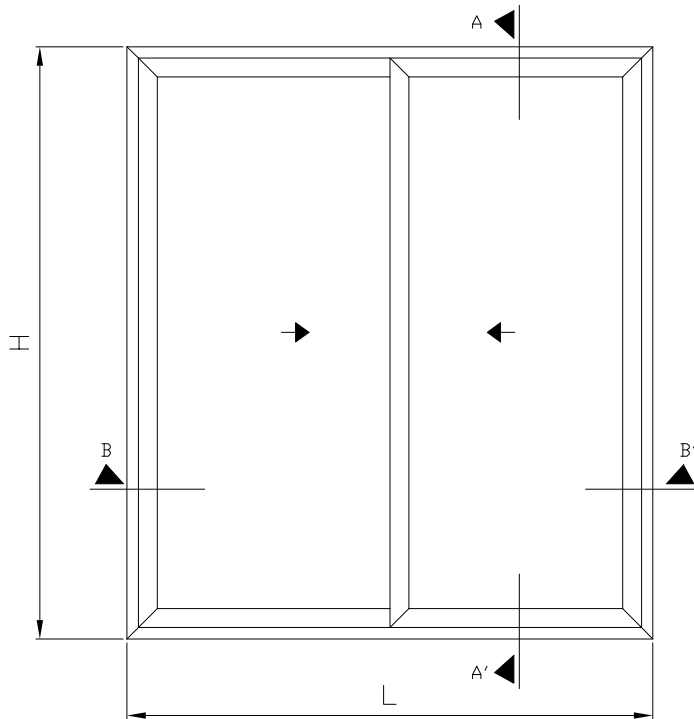

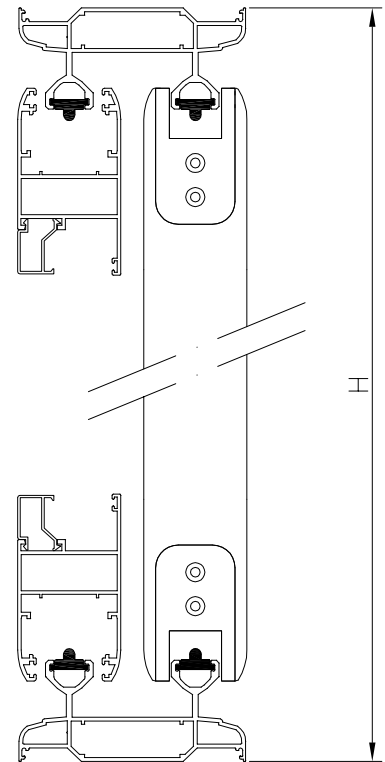

SECCION A-A'



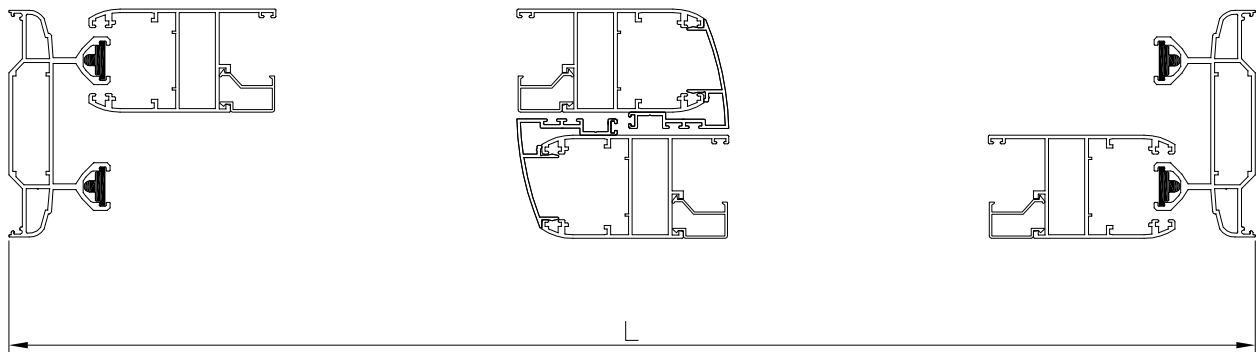



SECCION B-B'



Medidas de corte (mm)







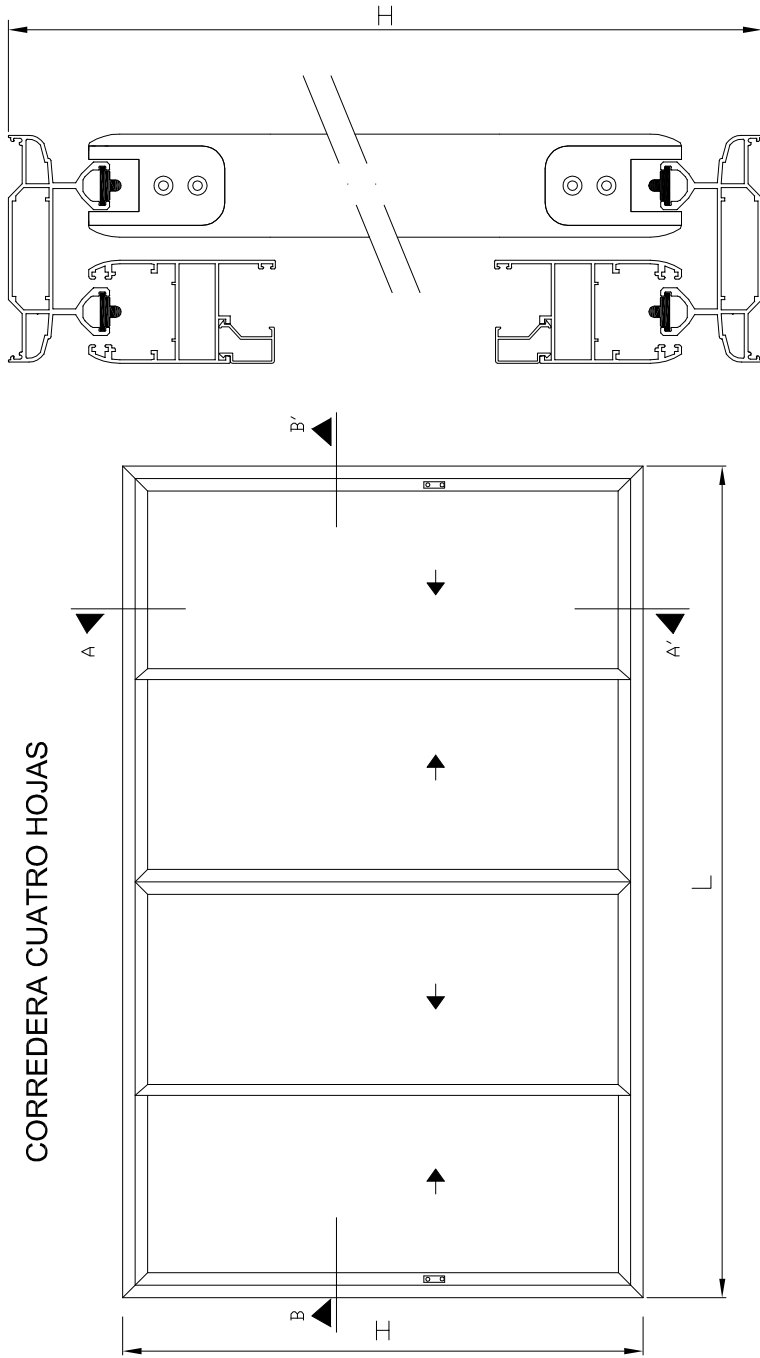

-  Marco superior: L
-  Marco lateral: H
-  Marco inferior: L

-  Hoja lateral-central: H-73
-  Hoja ruedas: (L/2)+8
-  Clip central: H-73
-  Perfil guia lateral: H-83.6
-  Perfil guia superior-inferior: L-92

CORREDERA CUATRO HOJAS



Medidas de corte (mm)

-  Marco superior: L
-  Marco lateral: H
-  Marco inferior: L
-  Hoja lateral-central: H-73
-  Hoja ruedas: (L/2)+8
-  Clip central: H-73
-  Perfil guía lateral: H-83.6
-  Perfil guía superior-inferior: L-92

SECCION A-A'

