

Guia superior
Ref: 4711

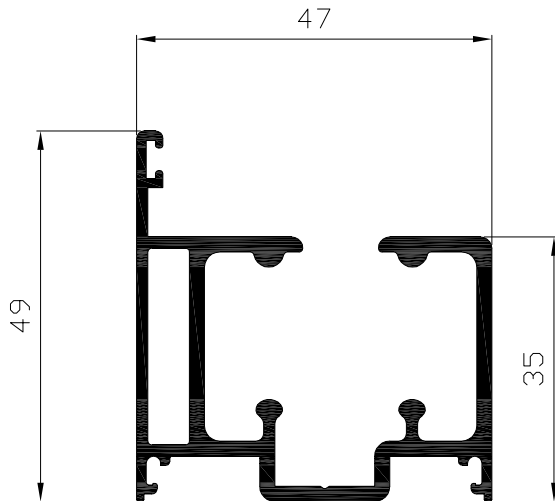

Marco lateral-guia inferior
Ref: 4713

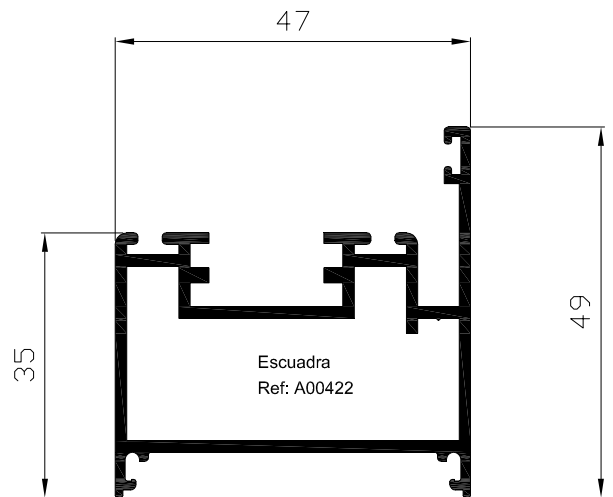

Hoja ventana plegable europea
Ref: 4714

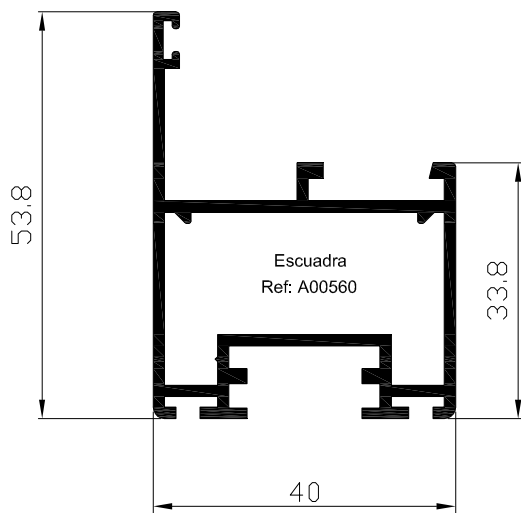

Hoja puerta plegable europea
Ref: 4724

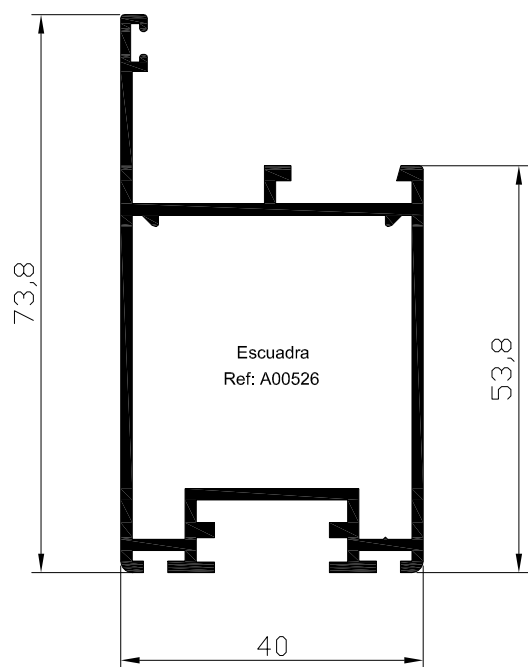

Hoja plegable mallorquina
Ref: 4716

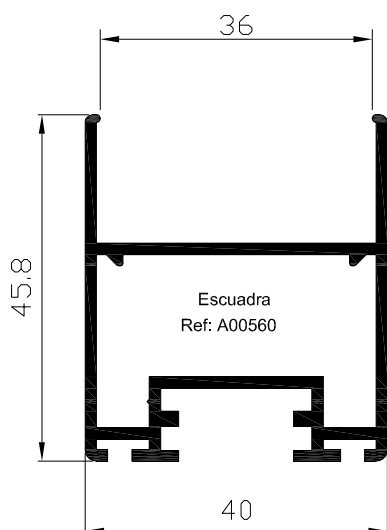

Compensador
Ref: 4707

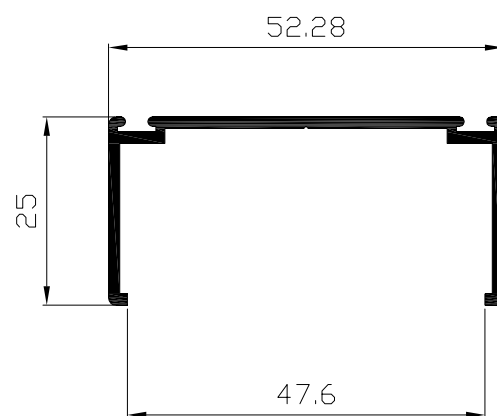

Guia inferior empotrada
Ref: 4718

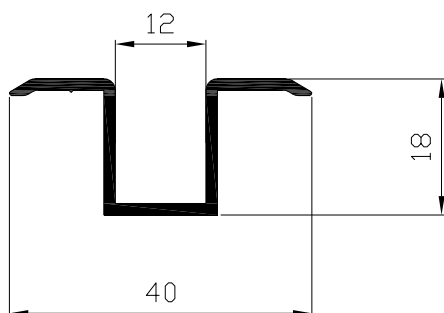

Perfil batiente
Ref: 4715

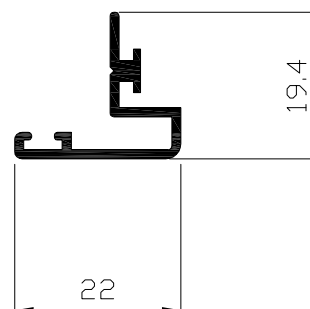

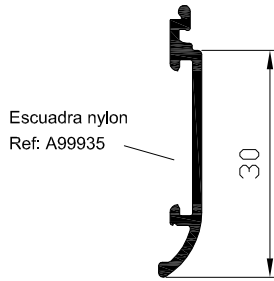

Solape 30 mm
Ref: 4130

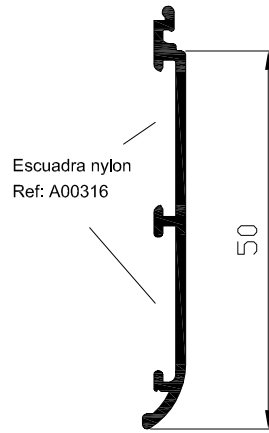

Solape 50 mm
Ref: 4150

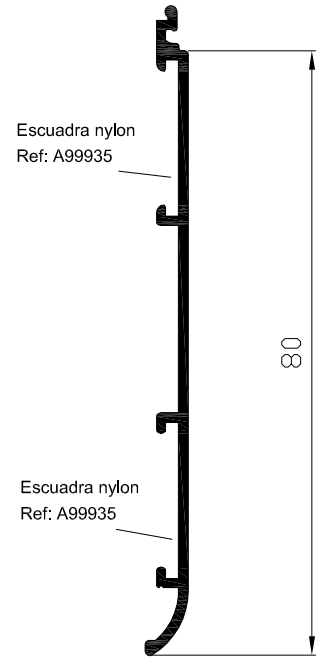

Solape 80 mm
Ref: 4180

Solape resalte
Ref: 4132

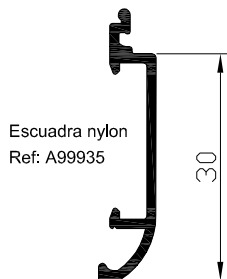

Solape compacto
Ref: 4133



Travesaño ventana
Ref: 4008

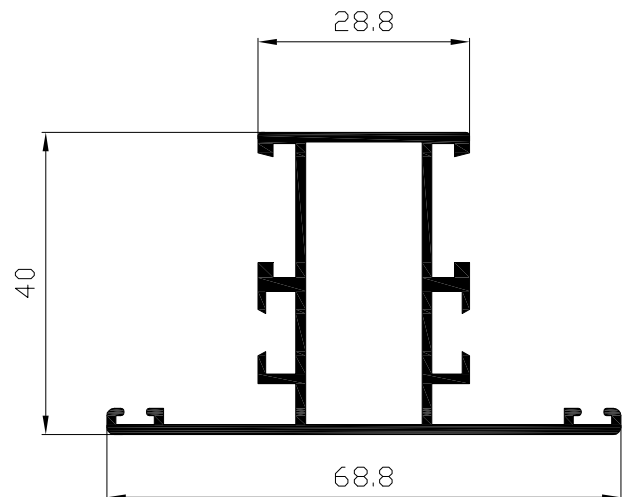

HUECO 9 mm

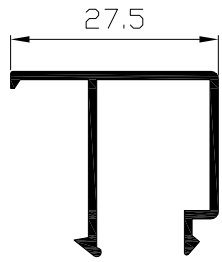

Junquillo recto
Ref: 4101

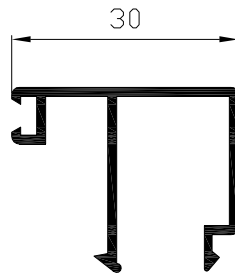

Junquillo recto
Ref: 4108

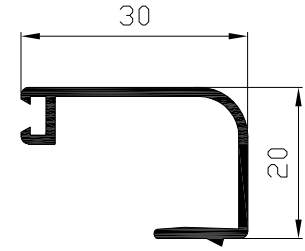

Junquillo curvo c.grapa
Ref: 4118

HUECO 6.5 mm

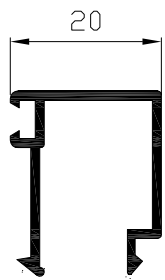

Junquillo recto
Ref: 4103

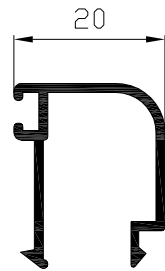

Junquillo curvo
Ref: 4123

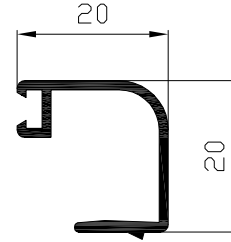

Junquillo curvo c.grapa
Ref: 4113

HUECO 16.5 mm

HUECO 20.5 mm

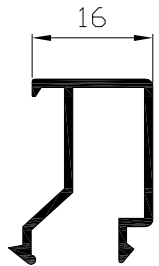

Junquillo recto
Ref: 4104

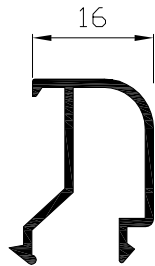

Junquillo curvo
Ref: 4124

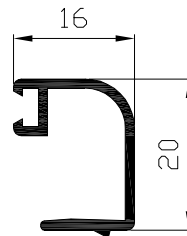

Junquillo curvo c.grapa
Ref: 4114

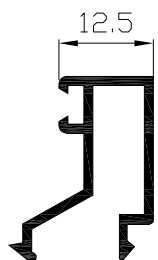

Junquillo recto
Ref: 4105

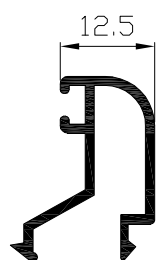

Junquillo curvo
Ref: 4125

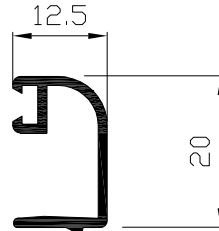

Junquillo curvo c.grapa
Ref: 4115

HUECO 24 mm

HUECO 29 mm

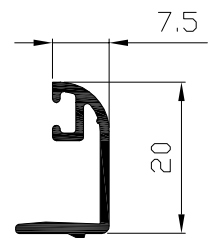

Junquillo curvo c.grapa
Ref: 4116

TIPOLOGIAS DE PUERTAS PLEGABLES

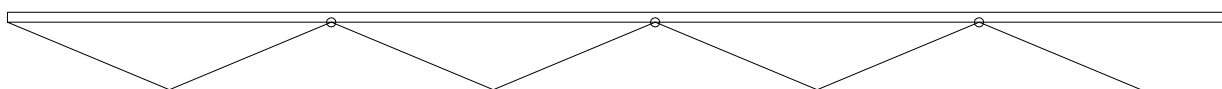
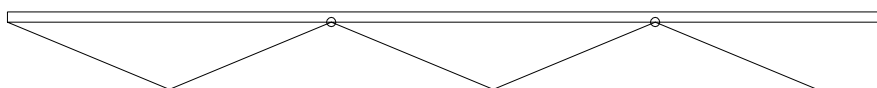
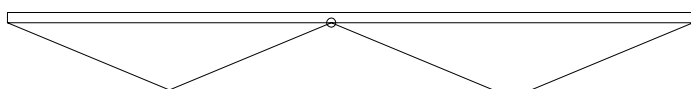
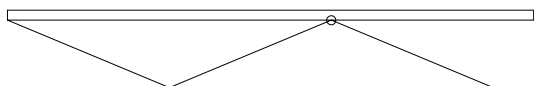

* El número de hojas a plegar siempre tiene que ser impar.

* El número de hojas no está limitado.

* No se pueden realizar apertura central con número de hojas par.

Ejemplo: NO ES POSIBLE: 2+2 , 4+4, 2+6 ..etc

SI ES POSIBLE: 3+1, 5+1, 3+3 ..etc

○ BISAGRA TANDEM

GUIA INFERIOR EMPOTRADA

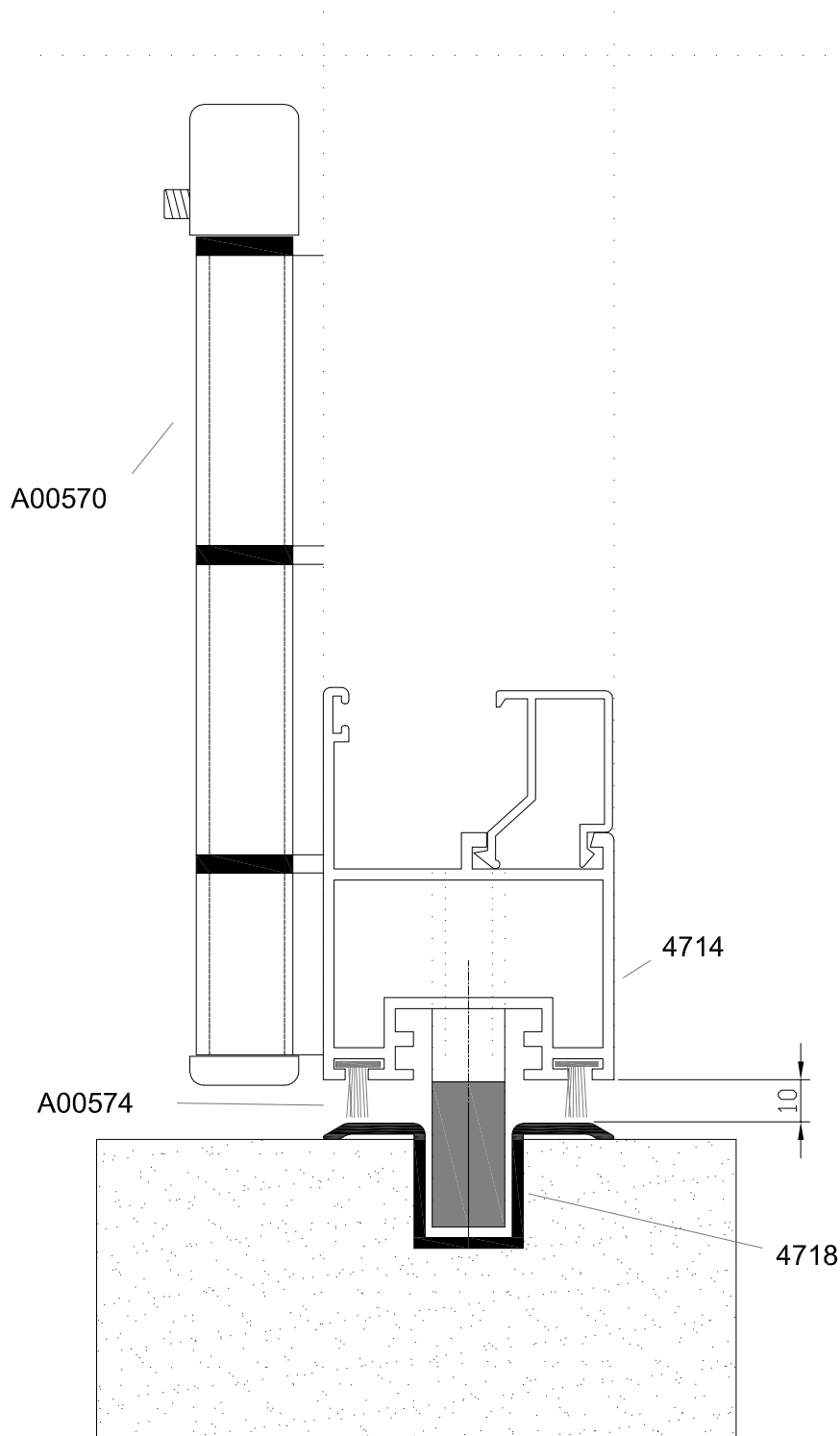

GUIA INFERIOR SUPERPUESTA

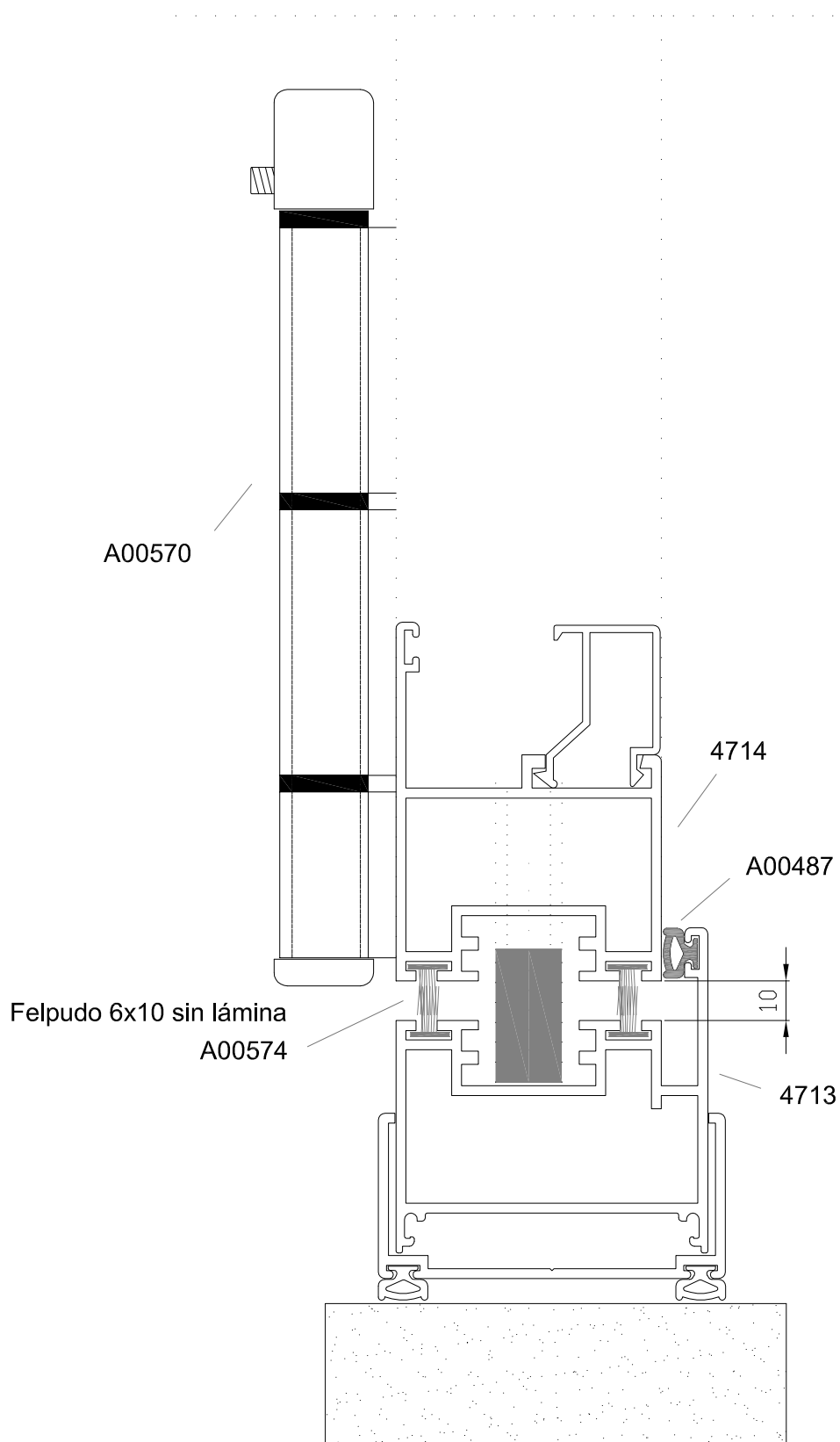

GUIA SUPERIOR

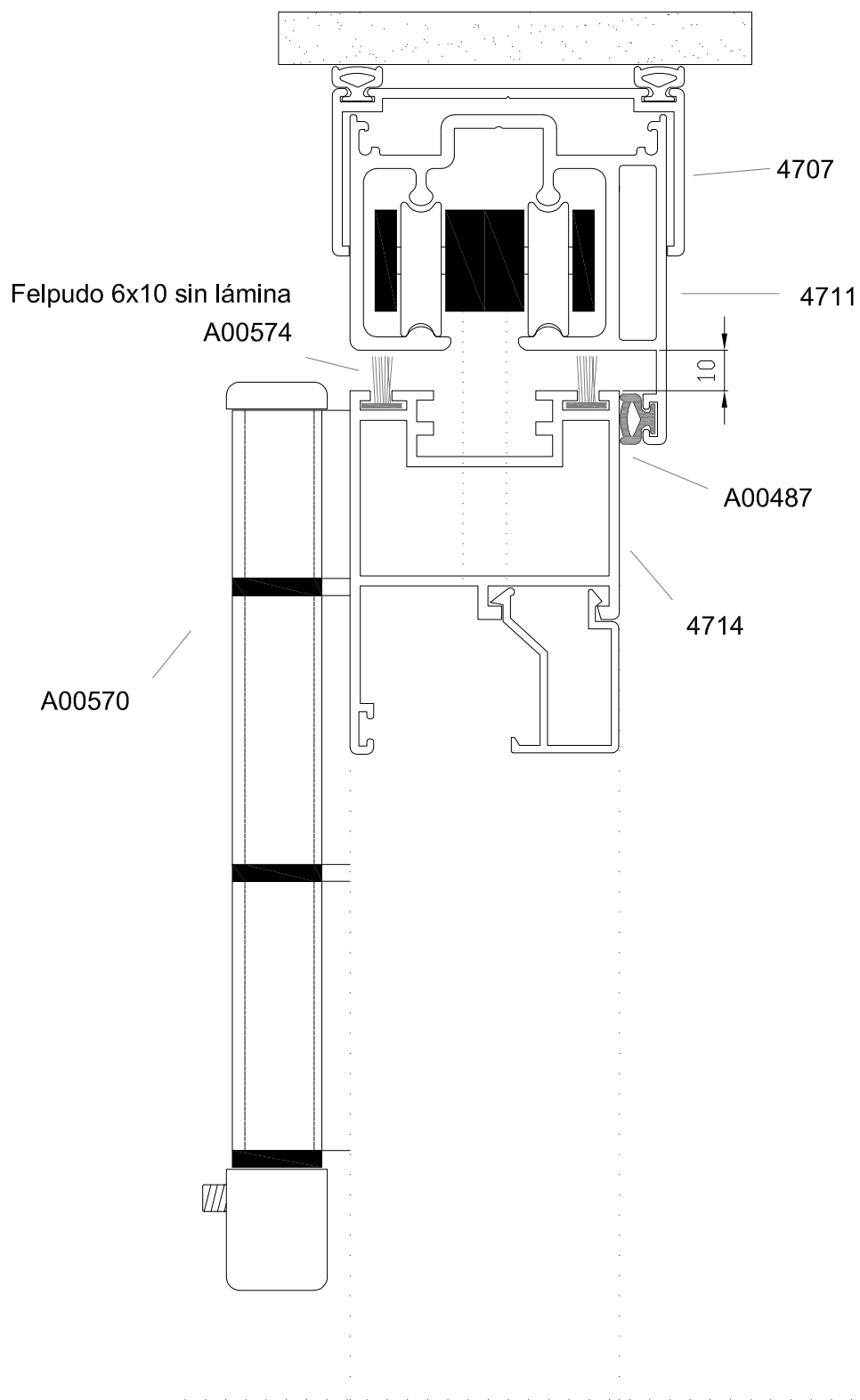

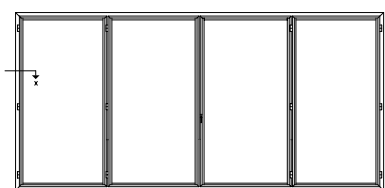

MARCO LATERAL

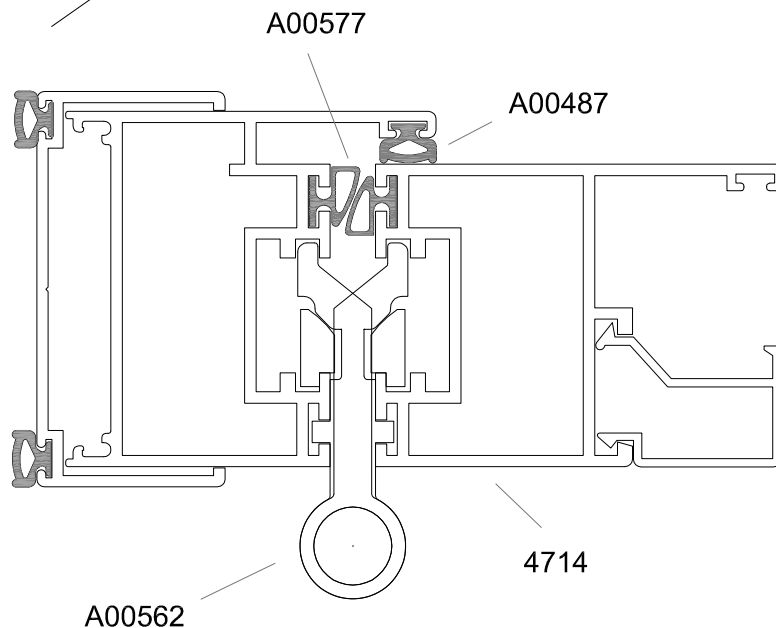
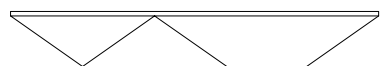

MARCO LATERAL-HOJA CIERRE

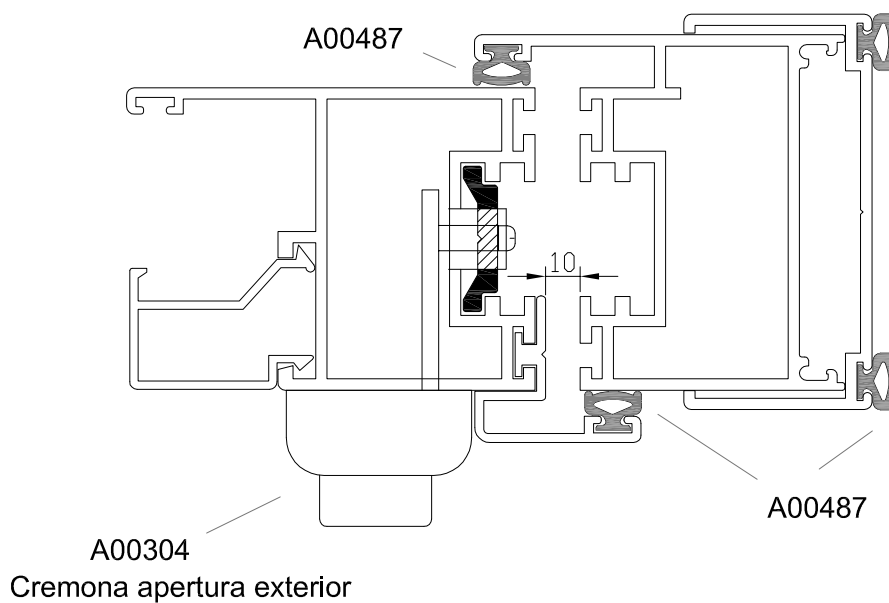

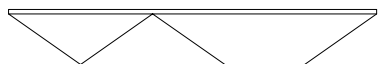
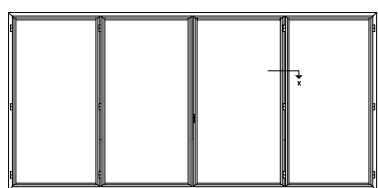

ENCUENTRO HOJAS CIERRE

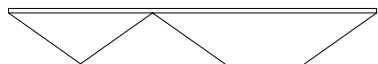
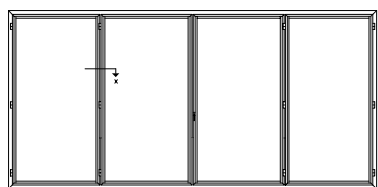
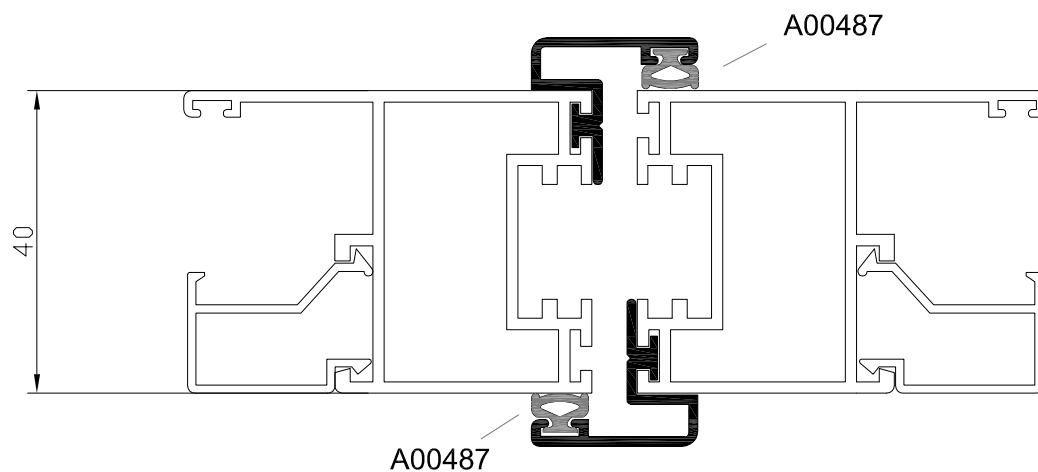

BISAGRA INTERIOR

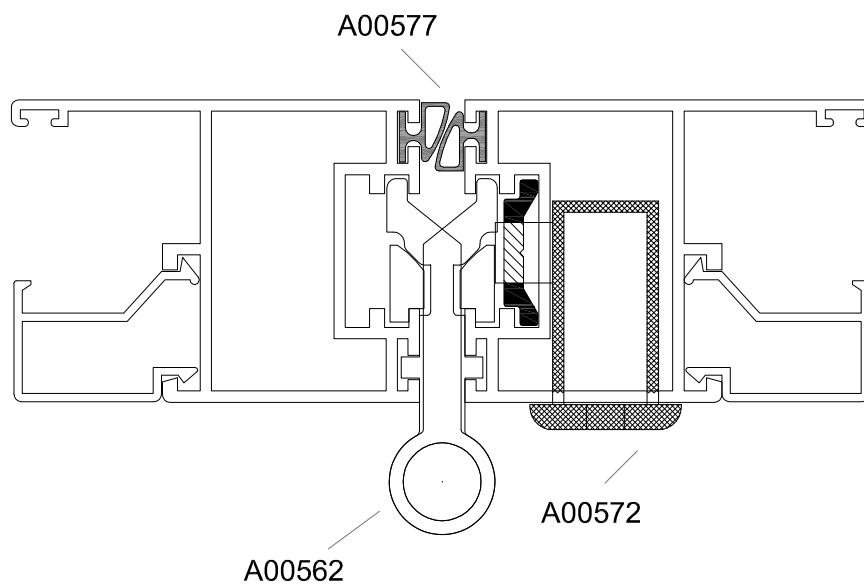

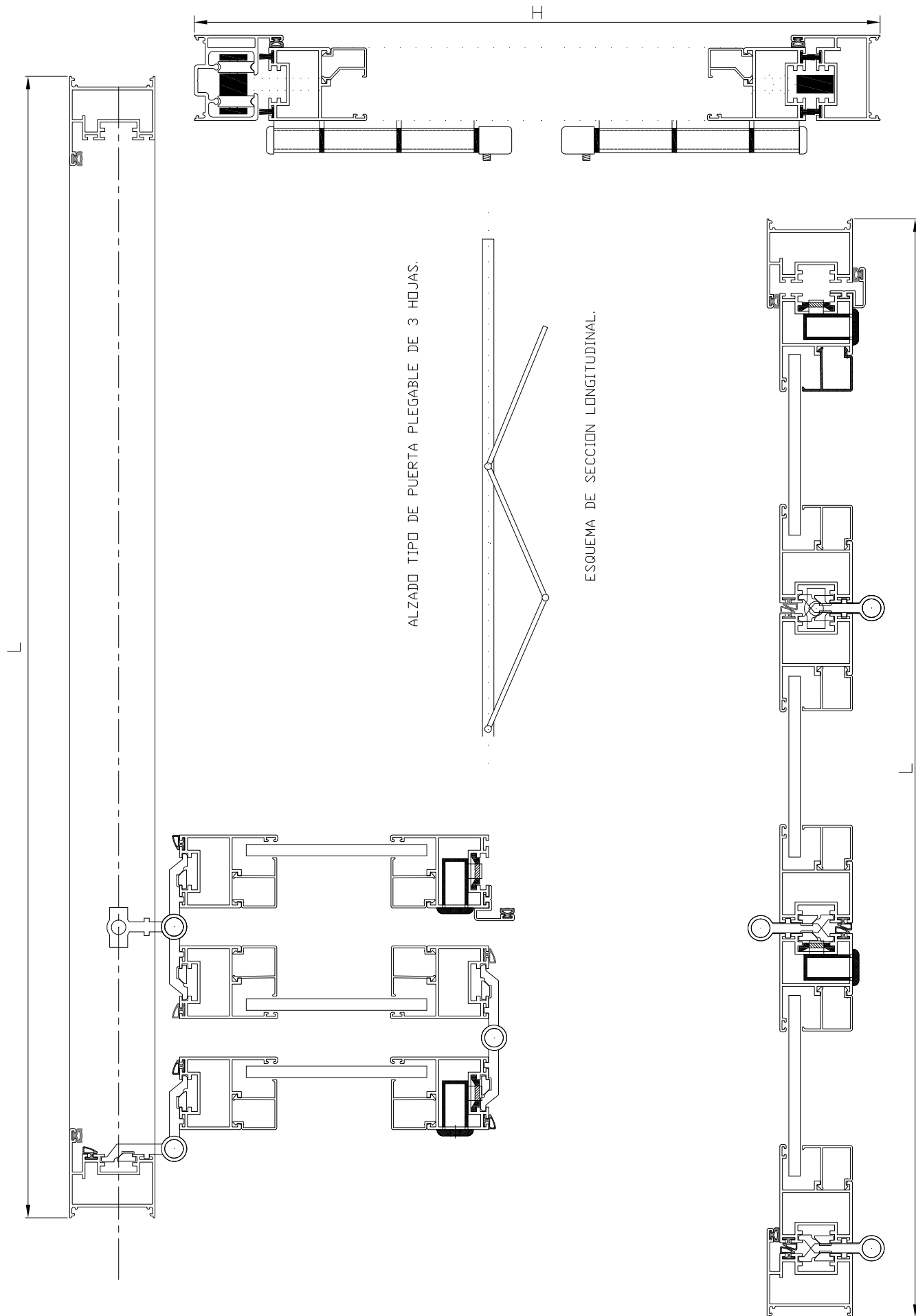

MALLORQUINA GRADUABLE CUATRO HOJAS

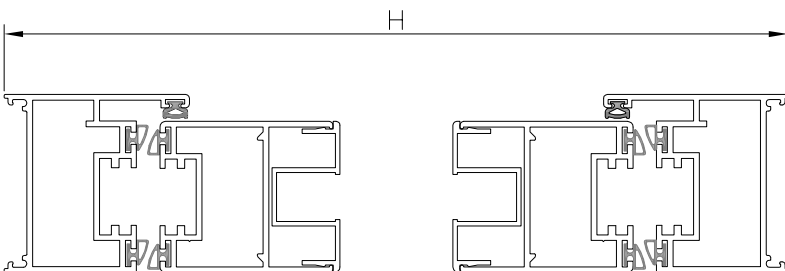
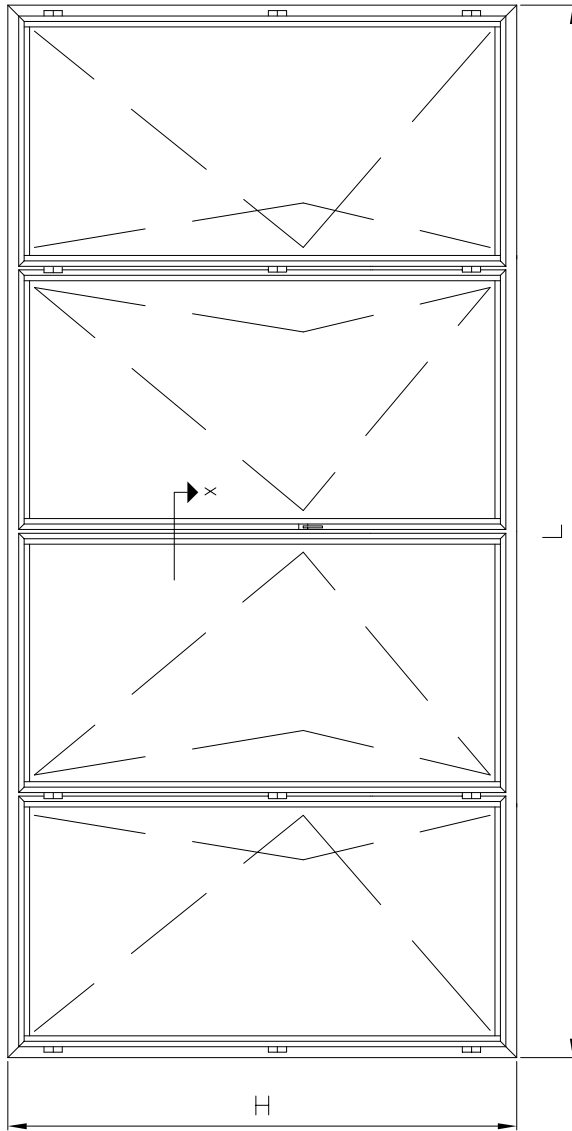

SECCION VERTICAL

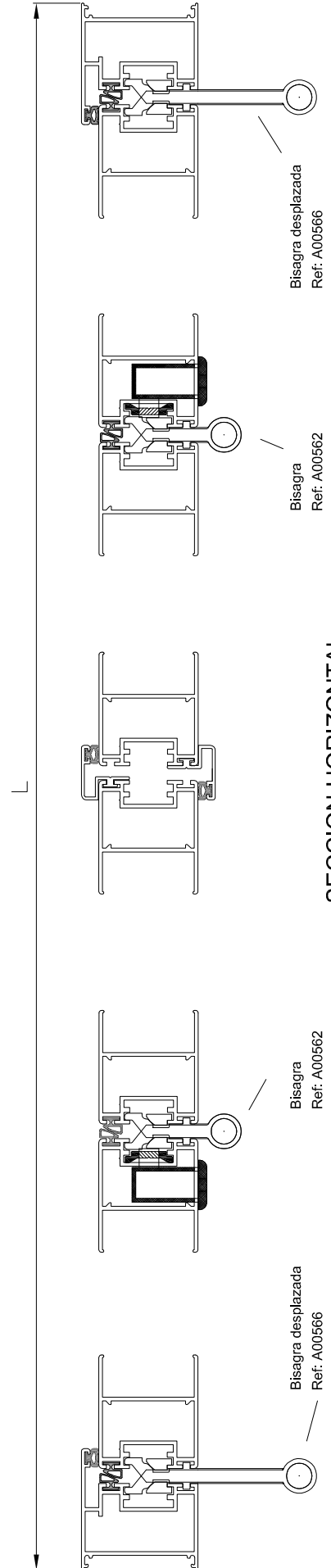

SECCION HORIZONTAL

ESCUADRA ENTRE GUIA SUPERIOR Y MARCO LATERAL

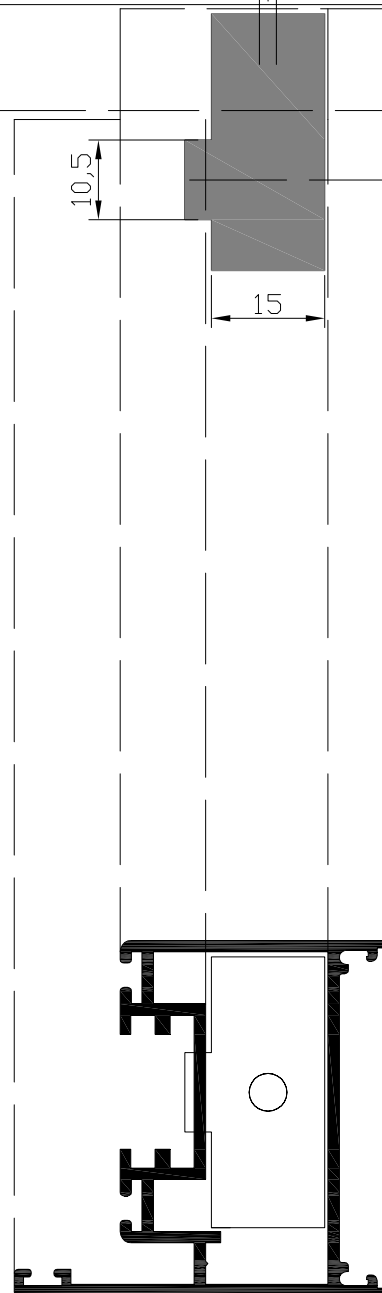
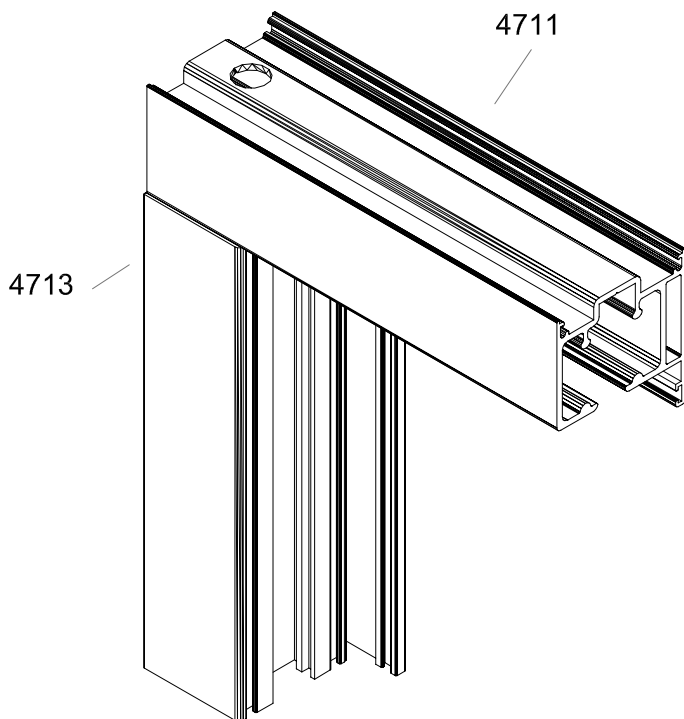
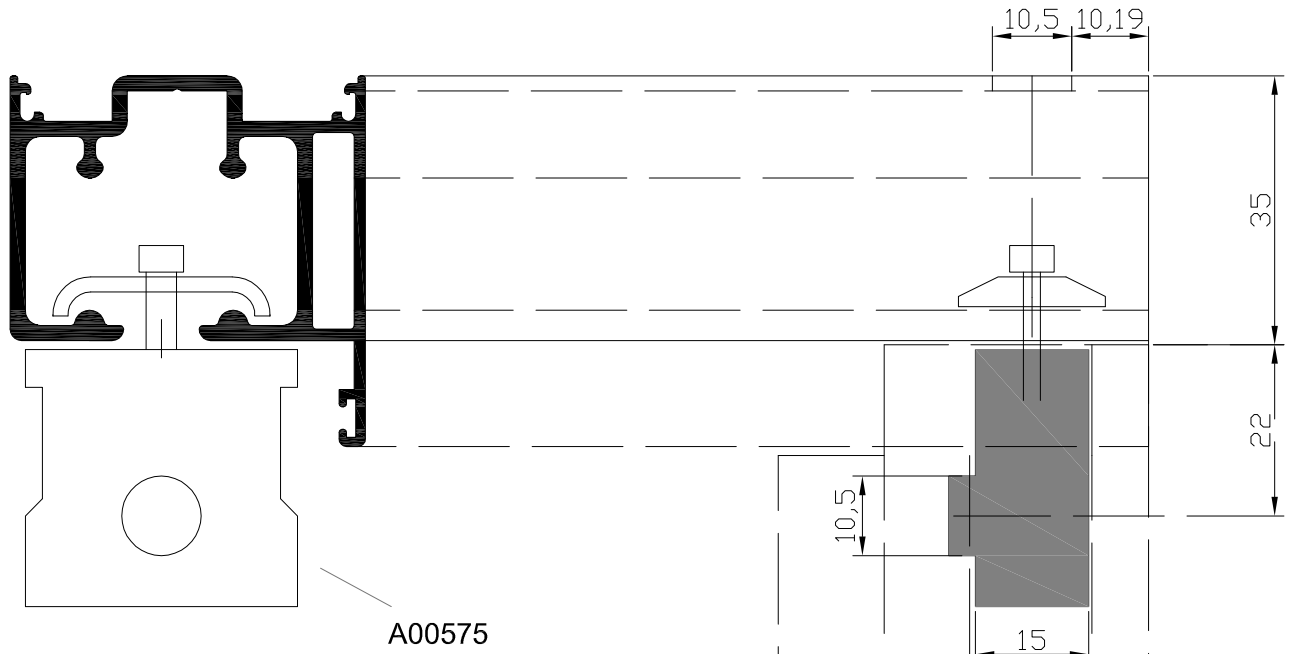

**RELACION DE ACCESORIOS PARA PLEGABLE
PRESCRIPCION DE INSTALACION**

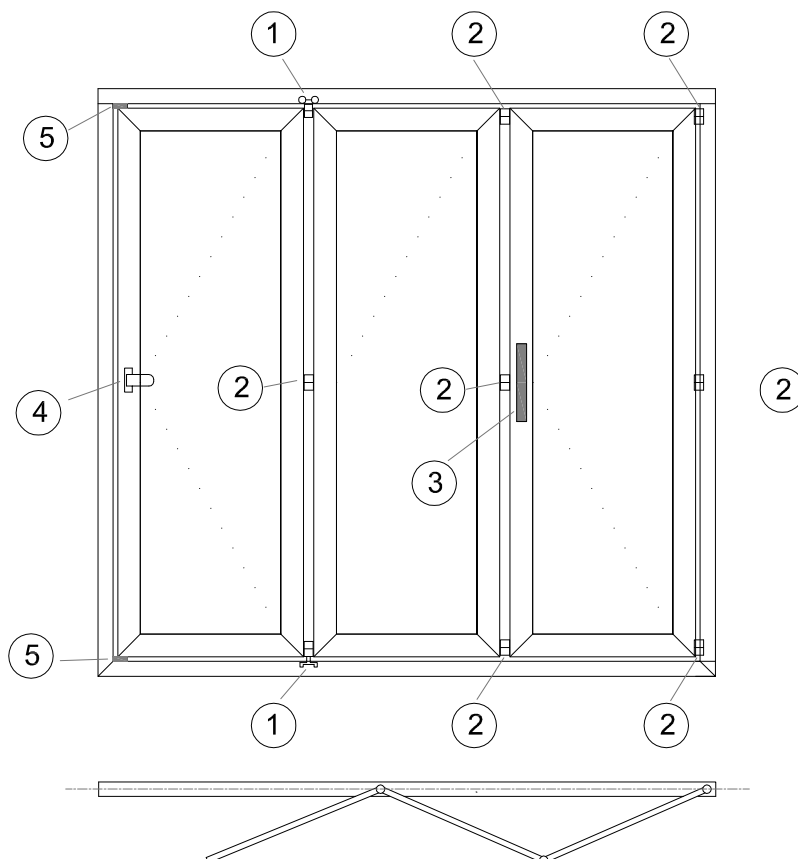

POS	DESCRIPCION	REF
1	Conjunto bisagra tandem	A00570
2	Bisagra individual	A00562
3	Pasador doble accion	A00572
	Tornillos de conexion a falleba	A00576
4	Cremona apertura exterior	A00304
	Pastilla de conexion con cremona	A99997
	Tornillos de conexion a falleba	A00576
5	Conjunto cerradero	A00573

PUNTAL CIERRE EN HOJAS

Hoja plegable - Guia superior: PUNTAL ESTRECHO

Hoja plegable - Guia inferior empotrada: PUNTAL ESTRECHO

Hoja plegable - Guia inferior superpuesta: PUNTAL ANCHO

DESCRIPCION	REF
Puntal estrecho	A00593
Puntal ancho	