

Marco coplanar
Ref: 4602

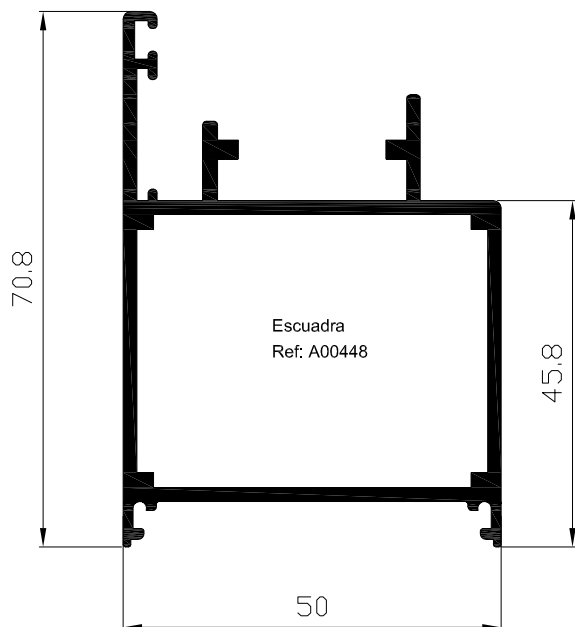

Hoja coplanar
Ref: 4605

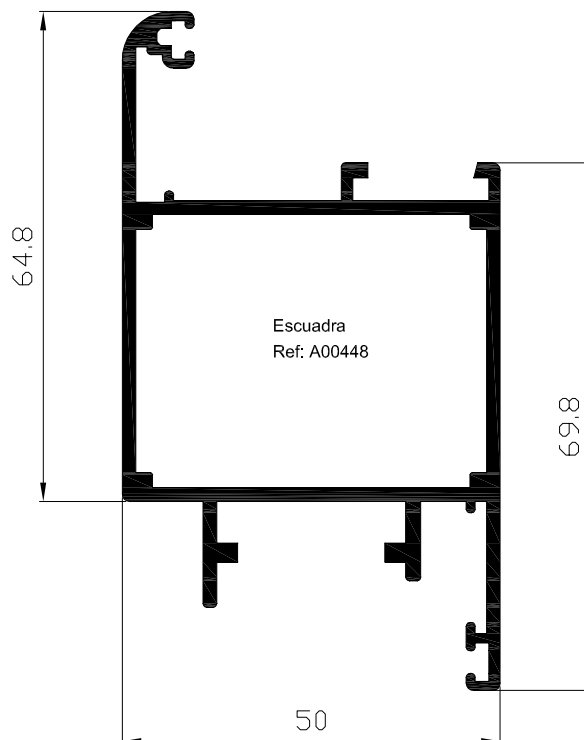

Marco fijo
Ref: 4621

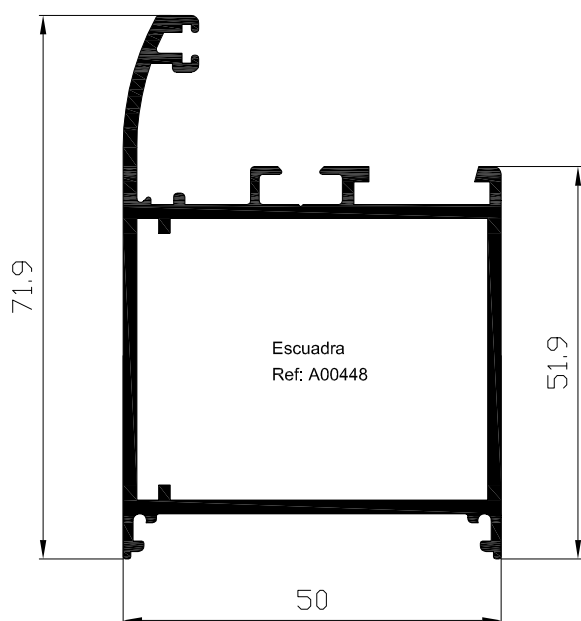

Hoja coplanar apert. exterior
Ref: 4615

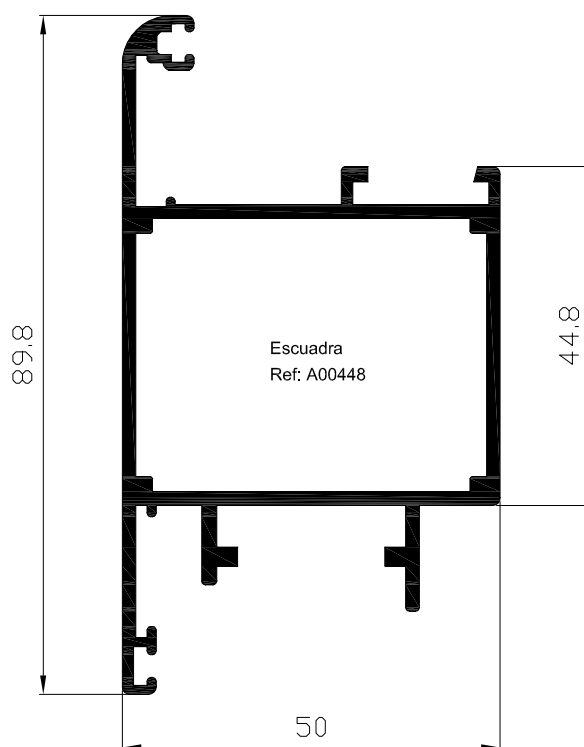

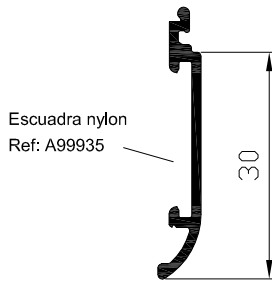

Solape 30 mm
Ref: 4130

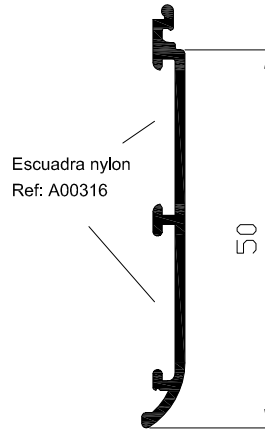

Solape 50 mm
Ref: 4150

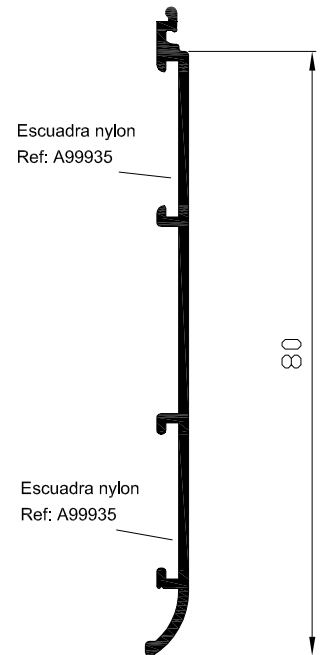

Solape 80 mm
Ref: 4180

Solape resalte
Ref: 4132

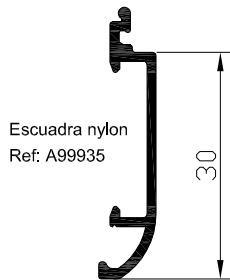

Solape compacto
Ref: 4133

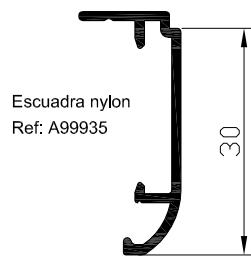

Unión de marcos
Ref: 8111

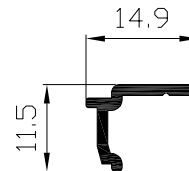

Vierteaguas
Ref: 4350

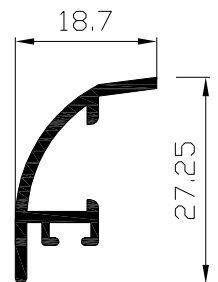

Travesaño zocalo
Ref: 4607

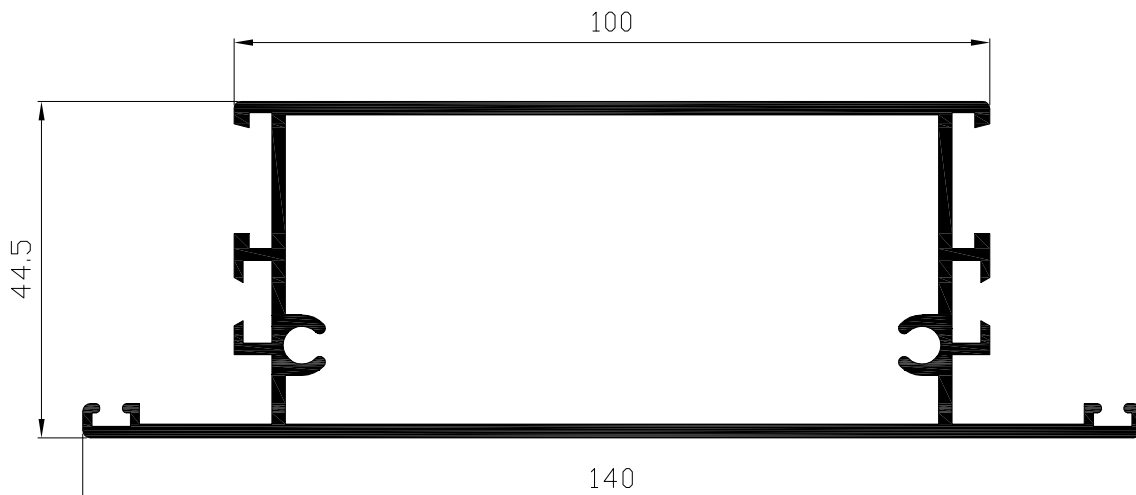

HUECO 13 mm

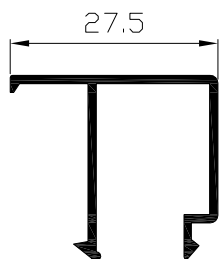

Junquillo recto
Ref: 4101

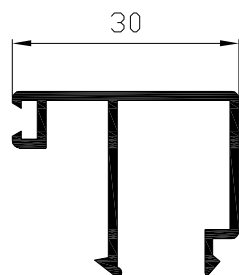

Junquillo recto
Ref: 4108

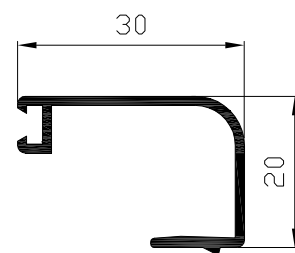

Junquillo curvo c.grapa
Ref: 4118

HUECO 10.5 mm

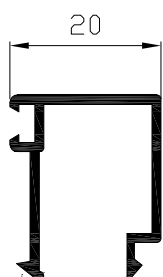

Junquillo recto
Ref: 4103

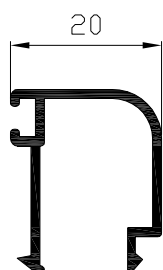

Junquillo curvo
Ref: 4123

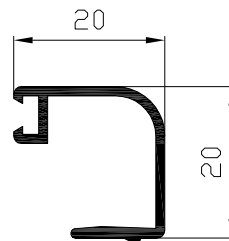

Junquillo curvo c.grapa
Ref: 4113

HUECO 20.5 mm

HUECO 24.5 mm

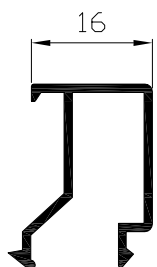

Junquillo recto
Ref: 4104

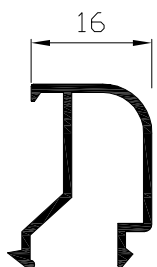

Junquillo curvo
Ref: 4124

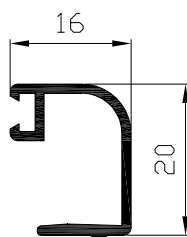

Junquillo curvo c.grapa
Ref: 4114

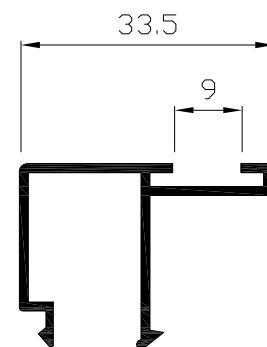

Junquillo zócalo
Ref: 4107

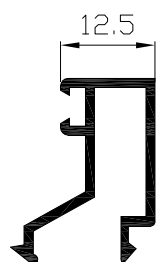

Junquillo recto
Ref: 4105

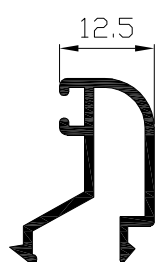

Junquillo curvo
Ref: 4125

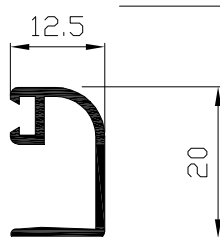

Junquillo curvo c.grapa
Ref: 4115

HUECO 28 mm

HUECO 33 mm

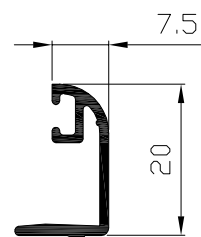

Junquillo curvo c.grapa
Ref: 4116

DETALLE COLOCACION TAPON INGLETE

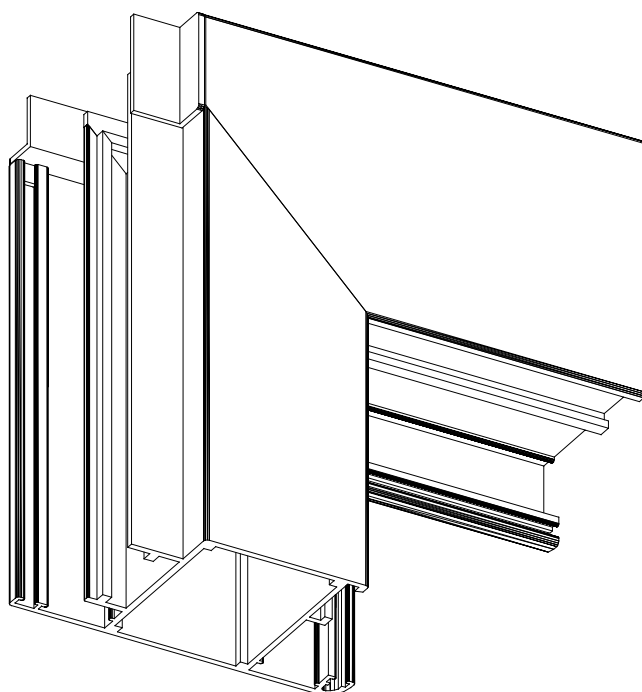
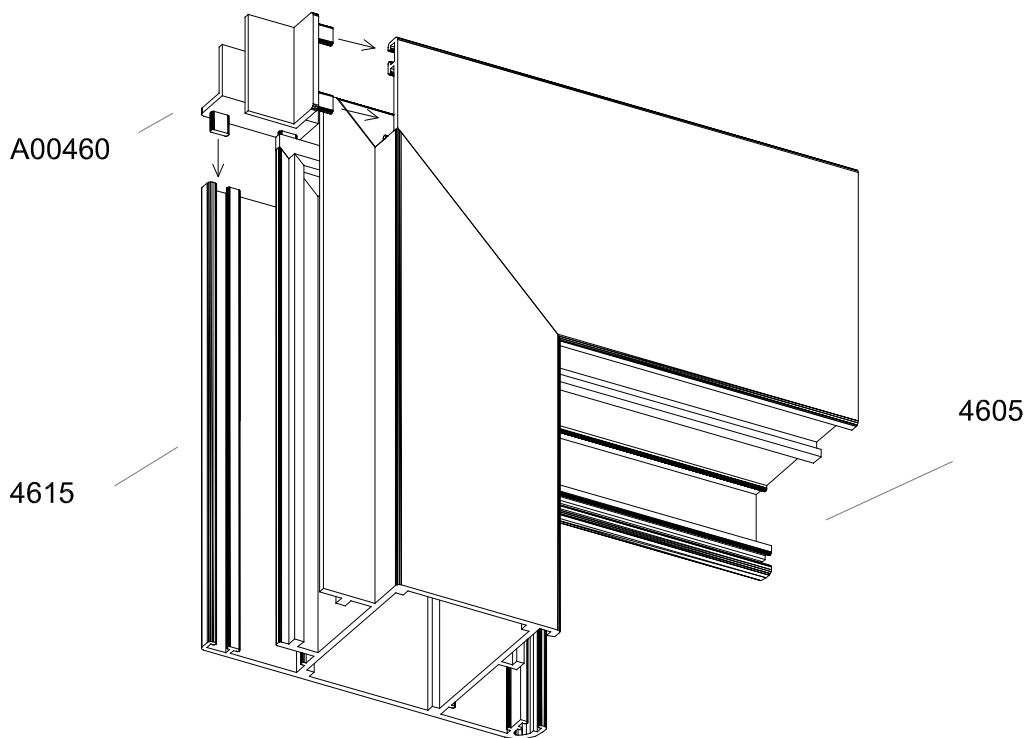

DETALLE PERFIL INVERSOR

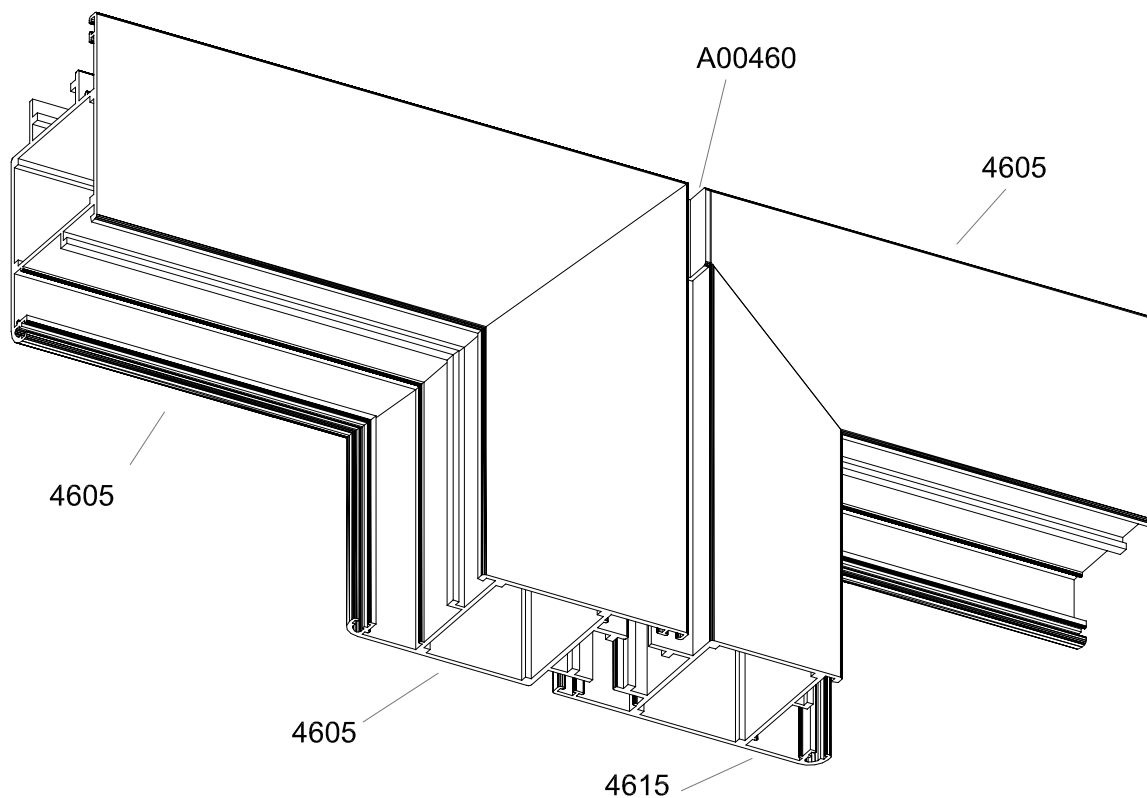

ALZADO

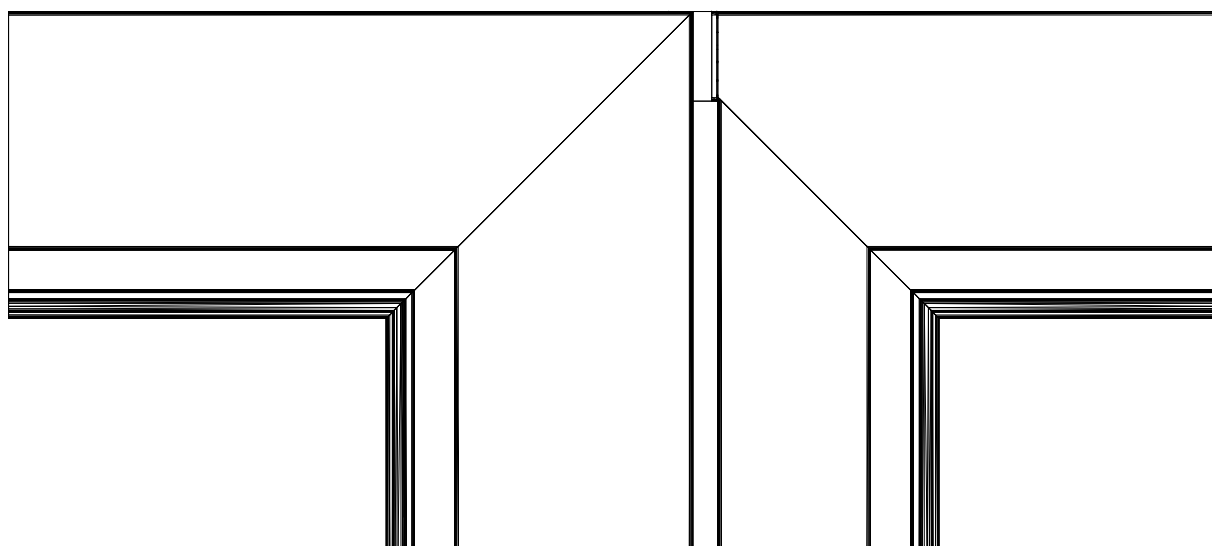

* Las referencias de las hojas se invierten en apertura exterior-interior

SECCION HORIZONTAL PUERTA COPLANAR

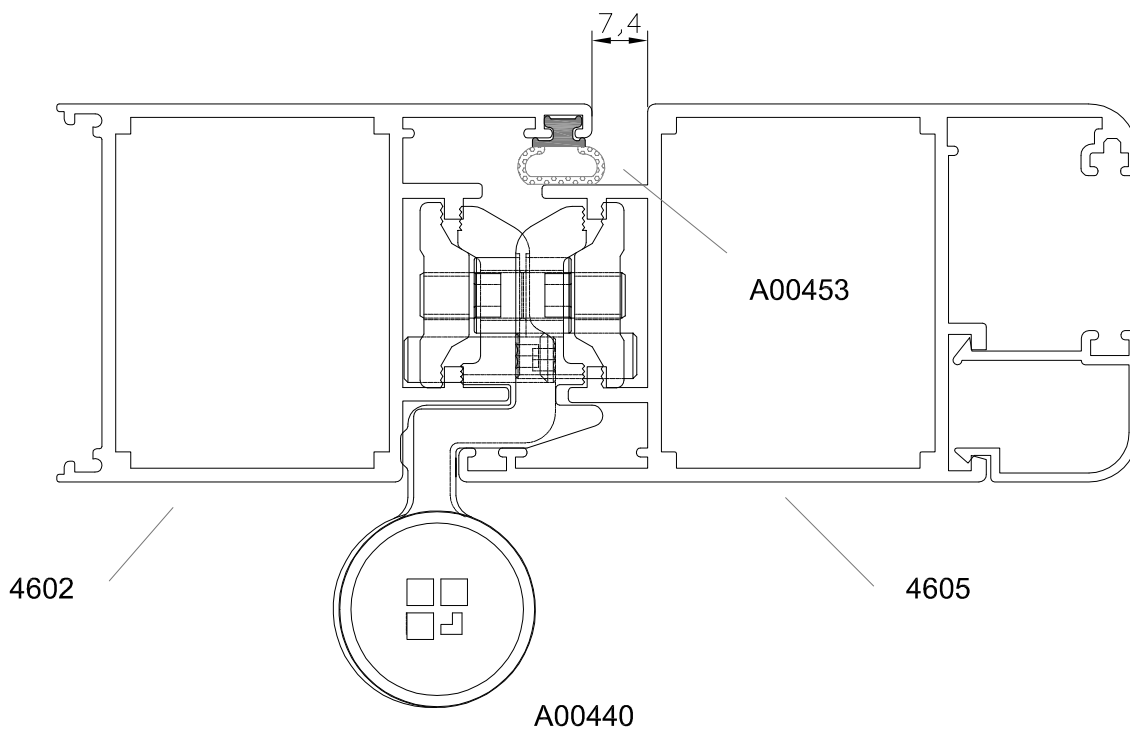

SECCION HORIZONTAL PUERTA VAIVEN

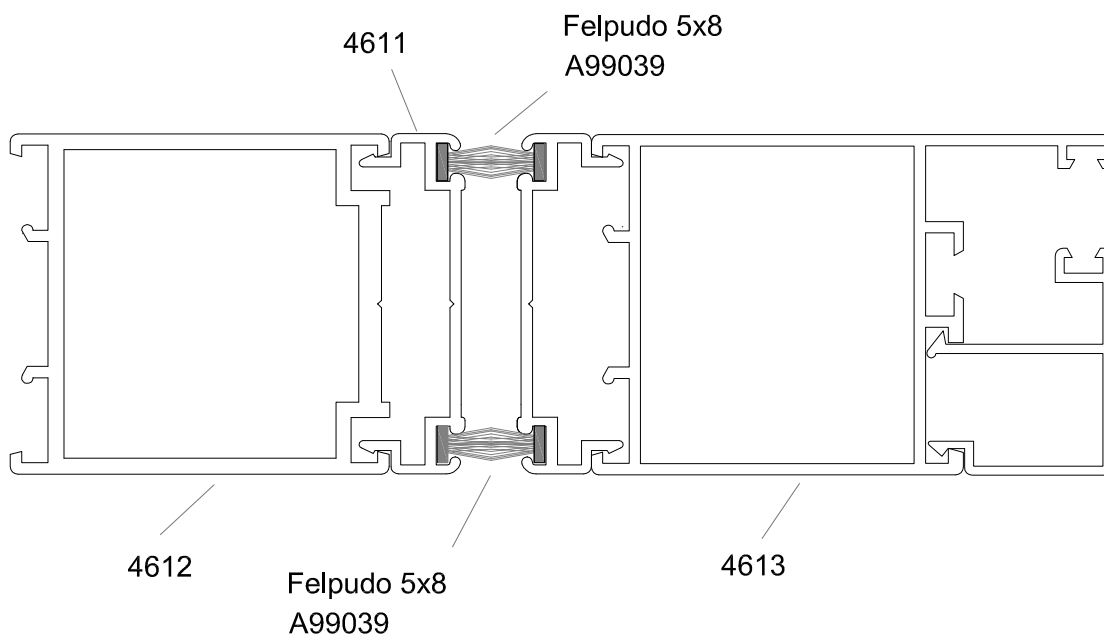

ESQUEMAS COLOCACION DE BISAGRAS SEGUN EL USO DE LAS PUERTAS CONSIDERANDO UNA PUERTA DE 2m. x 1m.		A00440	A00511
PUERTAS PARA USO PRIVADO			
PUERTAS PARA USO PUBLICO			
PUERTAS CON DIPOSITIVO DE CIERRE			
MEDIDAS ACONSEJABLES PARA COLOCACION DE LAS BISAGRAS			